

FIG. 24

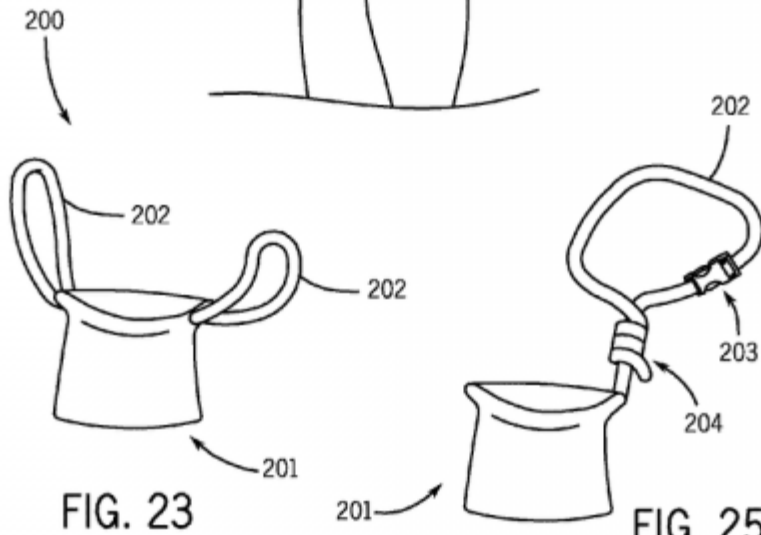

FIG. 23

FIG. 25